

Strip the insulation from the cable as specified in the table.

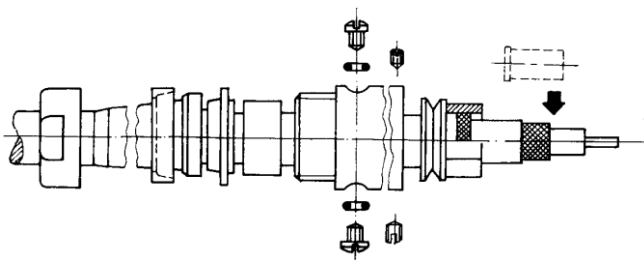

Reinforcement sleeve to stiffen the dielectric only for thin, highly-flexible triax cables having 8 or 9 mm diameter with inner flexible lead.

Only for additional clamping of the cable sheath

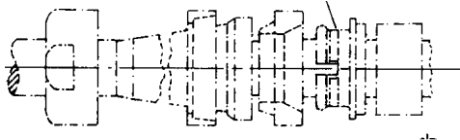

Slide the cable clamp and fittings over the cable. Place the outer braiding around the tension relief ring, slide over the large clamping sleeve, and crimp using the crimping pliers. (Exception: The second shield is soldered for cables ≥ 16 mm nominal diameter; no clamping sleeve is required in this case.)

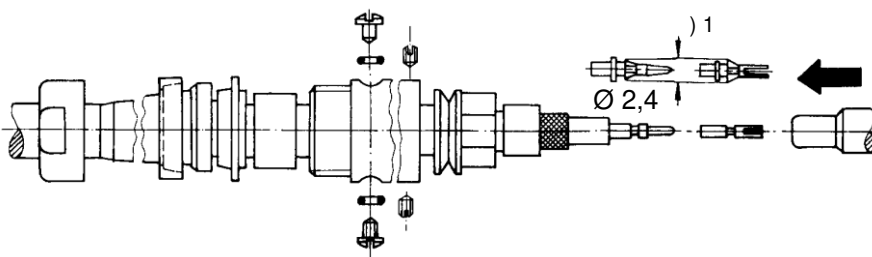

Slide the small clamping sleeve over the cable and use the expanding mandrel (if available) to widen the inner braiding. Slide the contact pin or contact socket as far as the dielectric on the inner conductor and crimp using the crimping pliers.

) 1 The release mandrel that has been inserted from the connector side can be used to remove changed contact pins and sockets again after they have been snapped in. If a contact pin or a contact socket has been removed, **check that the spring ring has a diameter of 2.4 before reinserting!** (Expand the spring ring if necessary.)

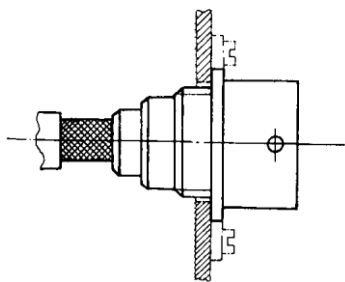
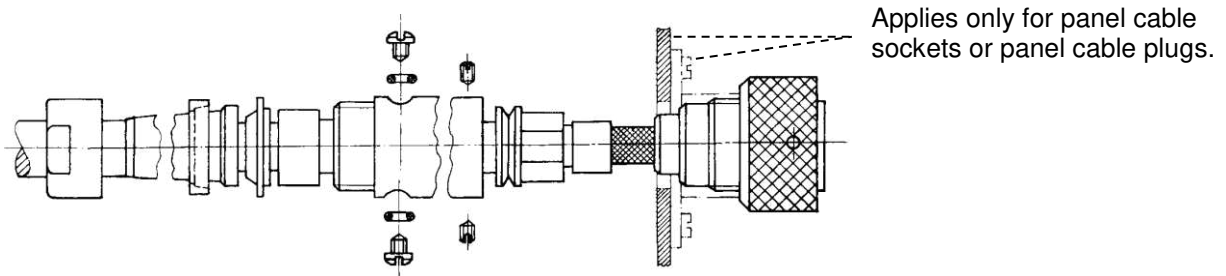

Insert the cable in the plug or socket connection until the contact pin or contact socket can be felt to engage. Then slide the clamping sleeve over the inner braiding.

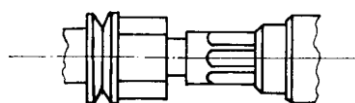

Place the plug or socket with the cable in the crimping pliers so that the plug or socket body is positioned at the press-in indentation, then crimp.

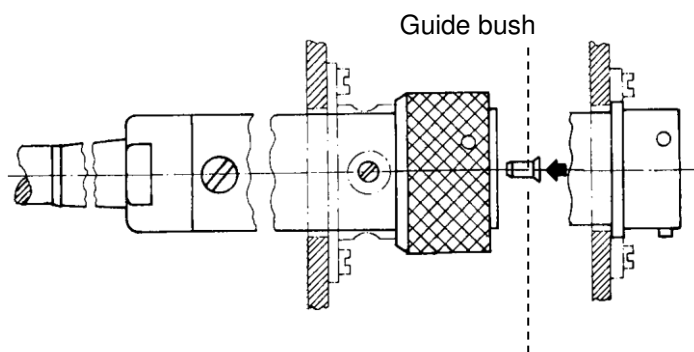

Slide forward the outer sleeve, screw tight and fasten using two threaded pins. Use two cheese-head screws to attach the tension relief ring. Finally screw the pressure nut with gasket and anti-kink sleeve (if available) on the outer sleeve.

Applies only for bushes: Impress guide bush using mandrel after the assembly has been completed correctly.

Assembly Instruction	a	b	c	d	e
101	-	-	24.0	15.0	4.0
102	49.0	26.0	24.0	15.0	4.0
104	51.5	28.5	24.0	15.0	4.0